

**Schiebe-Kipp-Beschläge / Standard / Selbsteinrastend**

Tilt and Slide Fittings / **Standard / Self-engaging system**

Ferrures pour coulissants à translation / **Standard / Enclenchement automatique**

Schuif-Valbeslag / **Standaard / met snapperplatt**

Okucia przesuwno-uchylne / **standard / z zatraskiem**

Otklopno-klizni-okovi / **Standard / Samouskočni**

Posuvně sklopné kování / **Standard / Automatická aretace**

Scorrevoli a ribalta / **Comando normale / Aggancio automatico**

Oscilo paralela / **Normal / Semi-automatica**

Συρόμενα-ανακλινόμενα / **Στάνταρτ / Αυτασφαλιζόμενα**



**ACHTUNG!**

Bei Einzel-entnahme muss der Beipackzettel dem Einzelteil hinzugefügt werden.

Bei Bedarf können Sie den Beipackzettel von der MACO-Homepage ([www.maco.eu](http://www.maco.eu)) herunterladen!

**ATTENTION!** When supplied singly ensure that a copy of this note is included within the package.

Additional copies of this sheet can be ordered from [enquiry@macouk.net](mailto:enquiry@macouk.net)

**ATTENTION!** Pour Des commandes unitaires la notice doit être jointe à chaque pièce unitaire. En cas de besoin, vous pouvez télécharger le document à partir du site MACO ([www.maco.eu](http://www.maco.eu))

**LET OP!** Bij afname van 1 enkel onderdeel moet de pakbon aan dat enkele onderdeel toegevoegd worden.

Indien gewenst kunt U de pakbon via de MACO-homepage ([www.maco.eu](http://www.maco.eu)) downloaden.

**POZOR!** Pri vađenju pojedinačnih dijelova, nužno je uz iste priložiti upute iz pakiranja. Po potrebi, upute iz pakiranja možete skinuti s MACO web stranice ([www.maco.eu](http://www.maco.eu))!

**POZOR!** Při jednotlivém odběru mimo balící množství musí být příbalový lístek přiložen k tomuto zboží.

Dle potřeby můžete též stáhnout příbalový lístek v elektronické podobě na stránkách MACO ([www.maco.eu](http://www.maco.eu)).

**ATTENZIONE!** In caso di acquisto di pezzi singoli, allegare le istruzioni di montaggio a ciascun pezzo. Se necessario il foglietto illustrativo è disponibile sul sito [www.maco.eu](http://www.maco.eu)!

**¡ATENCIÓN!** En caso de compra de componentes sueltos adjuntar las instrucciones de montaje a cada pieza.

Si necesario podéis solicitar copias de los hojas de instrucciones a MACO indicando el respectivo número de pedido.

**Προσοχή!** Σε περίπτωση ανοιγματος συσκευασίας πρέπει οι οδηγίες να συνοδεύουν το προϊόν. Σε αντίθετη περίπτωση μπορεί να παραγγελθούν οι οδηγίες με τον ακόλουθο κωδικό στην MACO.

**UWAGA!** Do pojedynczych elementów powinna zostać dołączona ulotka.

W razie potrzeby ulotka może zostać pobrana ze strony MACO ([www.maco.pl](http://www.maco.pl))

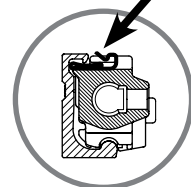
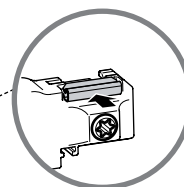
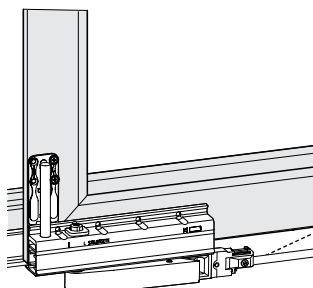
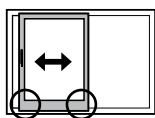
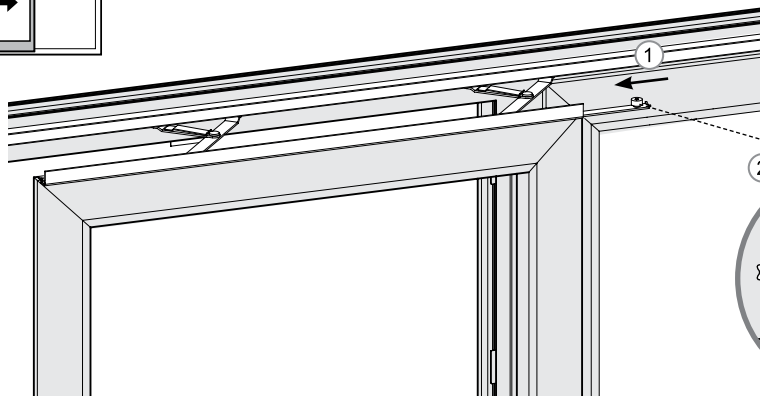
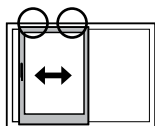
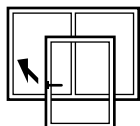

## Schiebe-Kipp-Beschläge / Zwangssteuerung

Tilt and Slide Fittings / **Positive control system**

Ferrures pour coulissants à translation / **Enclenchement automatique**

Schuif-Valbeslag / **gedwongen aantrek**

Okucia przesuwno-uchylne / **automatyczne**

Otklopno-klizni-okovi / **Automatski**

Posuvně sklopné kování/ **S nuceným ovládním**

Scorrevoli a ribalta / **Comando forzato**

Oscilo paralela / **Automatica**

Συρόμενα-ανακλινόμενα / **Εξαναγκασμένη έλξη**



### ACHTUNG!

Bei Einzel-entnahme muss der Beipackzettel dem Einzelteil hinzugefügt werden.

*Bei Bedarf können Sie den Beipackzettel von der MACO-Homepage ([www.maco.eu](http://www.maco.eu)) herunterladen!*

**ATTENTION!** When supplied singly ensure that a copy of this note is included within the package.

*Additional copies of this sheet can be ordered from [enquiry@macouk.net](mailto:enquiry@macouk.net)*

**ATTENTION!** Pour Des commandes unitaires la notice doit être jointe à chaque pièce unitaire. En cas de besoin, vous pouvez télécharger le document à partir du site MACO ([www.maco.eu](http://www.maco.eu))

**LET OP!** Bij afname van 1 enkel onderdeel moet de pakbon aan dat enkele onderdeel toegevoegd worden.

*Indien gewenst kunt U de pakbon via de MACO-homepage ([www.maco.eu](http://www.maco.eu)) downloaden.*

**POZOR!** Pri vađenju pojedinačnih dijelova, nužno je uz iste priložiti upute iz pakiranja. Po potrebi, upute iz pakiranja možete skinuti s MACO web stranice ([www.maco.eu/](http://www.maco.eu/))

**POZOR!** Při jednotlivém odběru mimo balící množství musí být příbalový lístek přiložen k tomuto zboží.

*Dle potřeby můžete též stáhnout příbalový lístek v elektronické podobě na stránkách MACO ([www.maco.eu](http://www.maco.eu)).*

**ATTENZIONE!** In caso di acquisto di pezzi singoli, allegare le istruzioni di montaggio a ciascun pezzo.

*Se necessario il foglietto illustrativo è disponibile sul sito [www.maco.eu/](http://www.maco.eu/)*

**¡ATENCIÓN!** En caso de compra de componentes sueltos adjuntar las instrucciones de montaje a cada pieza.

*Si necesario podéis solicitar copias de los hojas de instrucciones a MACO indicando el respectivo número de pedido.*

**Προσοχή!** Σε περίπτωση ανοίγματος συσκευασίας πρέπει οι οδηγίες να συνοδεύουν το προϊόν. Σε αντίθετη περίπτωση μπορεί να παραγγελθούν οι οδηγίες με τον ακόλουθο κωδικό στην MACO.

**UWAGA!** Do pojedynczych elementów powinna zostać dołączona ulotka.

*W razie potrzeby ulotka może zostać pobrana ze strony MACO ([www.maco.pl](http://www.maco.pl))*

