



TECHNOLOGY IN MOTION

MACO-InfinityView

THE LIFT AND SLIDE REVOLUTION







InfinityView Move your limits

InfinityView pushes limits and sets new boundaries. Extend your product portfolio with the innovative lift and slide system from MACO. The sash frame is only 50 mm wide, consisting of timber on the inside and aluminium on the outside, while still preserving flawless static properties, thanks to its fibreglass-reinforced plastic core. InfinityView gives you unprecedented design freedom. Your customers will enjoy an even more naturally lit room, along with a limitless view over the horizon.

That's not all! Our revolutionary modular system is at the forefront of innovation, with its conveniently modular features too. True barrier free access and motorisation create a stylishly comfortable, yet functional experience. Plus, InfinityView is suitable for passive houses and secure according to Resistance Class 2.

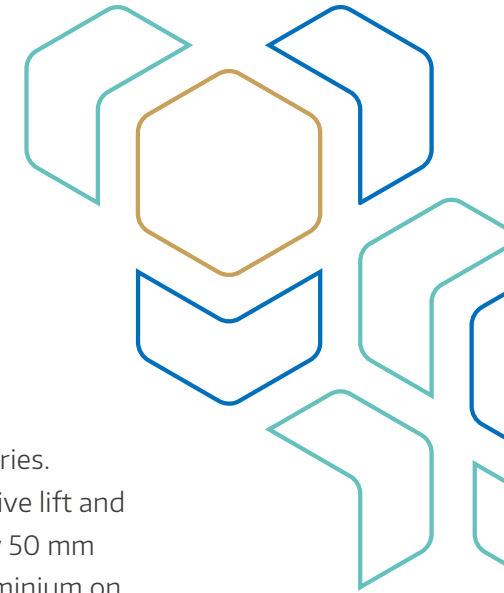

InfinityView

Manual version

We are proudly presenting the InfinityView version with manual control. It has a fibreglass-reinforced plastic core, as well as an ultra-slim frame made of timber on the inside and aluminium on the outside. In addition, the threshold is absolutely obstacle-free. It does not even protrude one millimetre out of the ground, creating obstacle-free use. On top of all of that, its hidden locks also create an unforgettable minimalist look.

Technical data

- › Sash frame width: 50 mm
- › Sash height: 1,835 to 2,860 mm
- › Sash width: max. 3,385 mm
- › Sash weight: up to 300 kg
- › Locking mechanism: hook drive gear
- › Gear size: 4 and 5
- › Backset: 27.5 mm



HOOK DRIVE GEAR



THRESHOLD
Absolutely obstacle-free
(zero barrier)

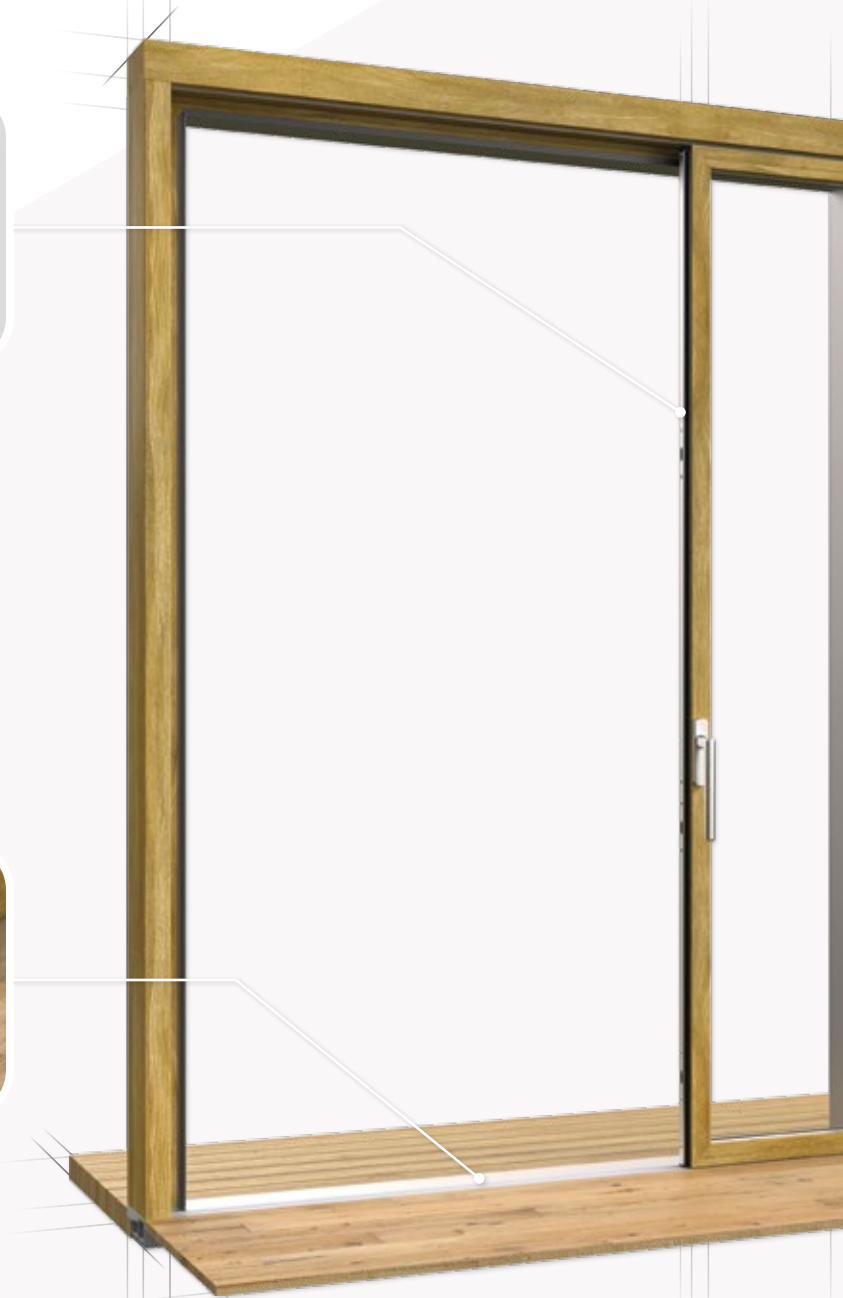

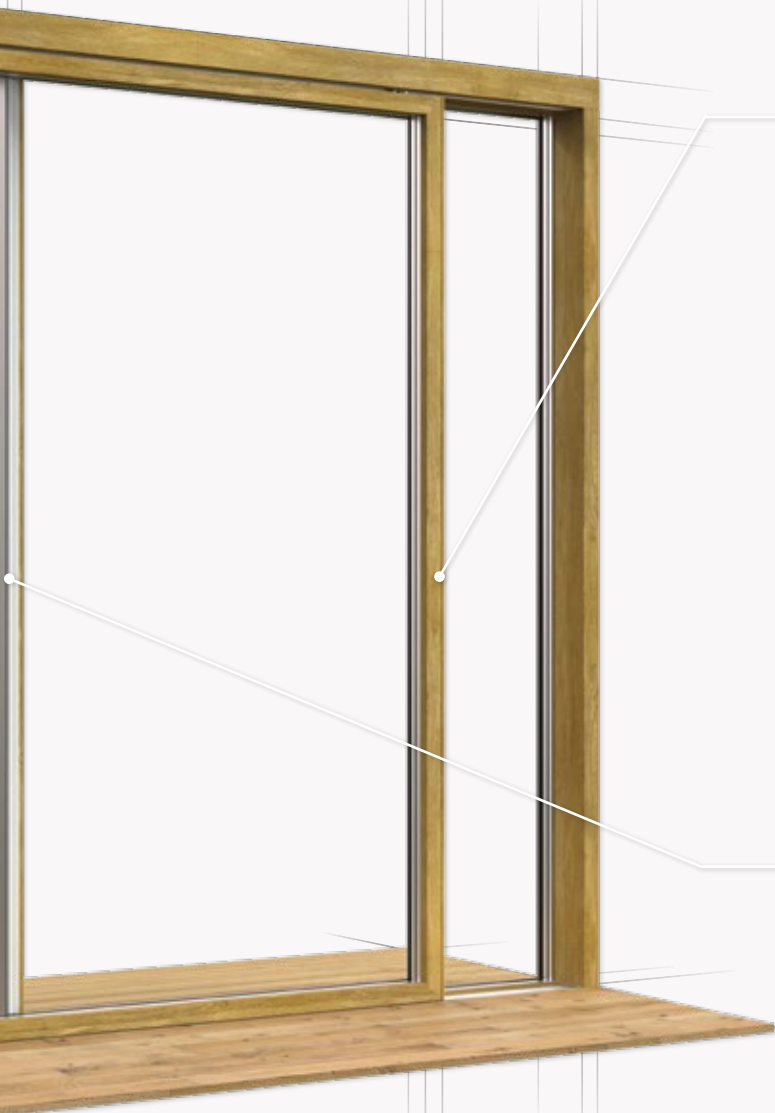

REINFORCEMENT PROFILE
Fibreglass-reinforced plastic core

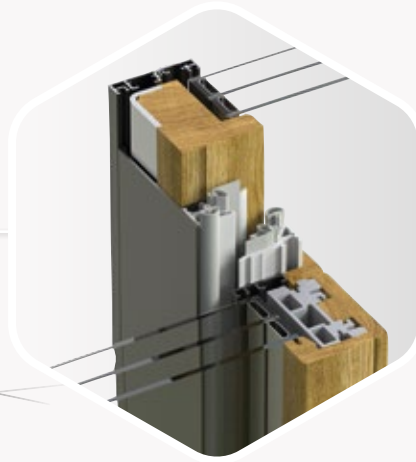

CENTRAL GASKET RAIL

MACO-Schemes

Scheme A left



Scheme A right



Scheme C

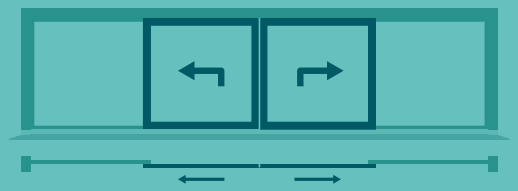

InfinityView

Motorised version

Do you have customers who want to move their InfinityView sliding system at the touch of button? No problem! The HS MACO Comfort drive makes this wish a reality. It allows these luxuries to be easy and convenient, while not compromising the design at all. You can still create your elements using our proven MACO standard hardware fittings. The only difference here are the motor-related components.

Technische Daten

- › Sash frame width: 50 mm
- › Sash height: 1,835 to 2,860 mm
- › Sash width: max. 3,385 mm
- › Sash weight: up to 200 kg
- › Locking mechanism: hook drive gear
- › Gear size: 4 and 5
- › Backset: 27.5 mm



OPERATION

Options: 3-button panel (shown), 1-button panel, lockable button, smartphone app



HUB MOTOR WITH DRIVE GEAR

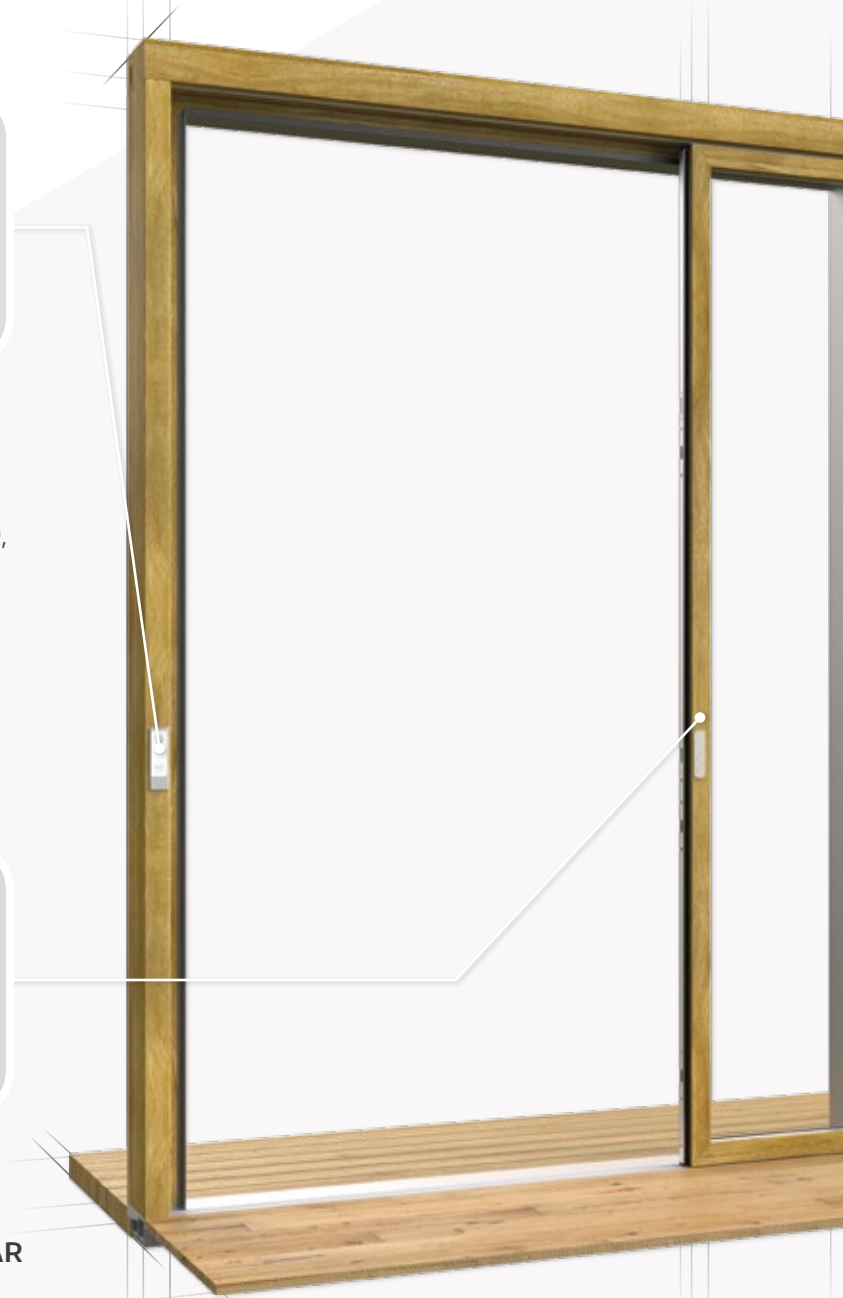



SLIDE MOTOR



EXTERIOR
Every version is covered
with aluminium

MACO-Schemes

Scheme A left

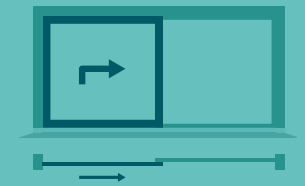

Scheme A right



Uniquely beautiful design

Benefits for fabricators

As a fabricator, you'll love the opportunities that our ingenious InfinityView gives you. It enables you to adapt your lift and slide door to individual living situations and your customers every wish. On top of that, MACO will be with you every step of the way, as a reliable full-service provider. That will give you the support you need to produce sliding doors with a unique design.

Further benefits

- › Sash elements made to measure (including milling and drilling work)
- › Open up new revenue streams
- › Participation in architectural tenders
- › Tested and verified system (CE label, RC verification)
- › Uses proven MACO standard fittings
- › No adapter profile necessary for obstacle-free threshold
- › Created in collaboration with the leading aluminium shell manufacturers





InfinityView

Convinces your customers

Design

- › Slim frames and large areas of glass flood the room with light and open up a panoramic view
- › Nothing blocks the view – no visible locks or latches and no annoying edges or corners on the frame
- › Wide range of models lets you adapt your product to your customer's home

Convenience

- › Zero barrier (certified by the ift Rosenheim institute) made possible with a floor-embedded roller track
- › Motorised version makes it easy to move large elements
- › Control your motorised InfinityView with a smartphone or with wireless radio signals
- › Smart-home ready
- › Suitable for passive houses (U-value ≤ 0.8)

Security

- › Can be combined with RC2 security equipment





Service? Infinity!

MACO gives you 360-degree service. You'll benefit from our resolutely system-oriented approach, that goes way beyond the product itself. At MACO, we'll support you from start to finish, so you can focus on your customers.

For InfinityView, we deliver you custom-made sash frames, including all drilling and milling work.

That's not all! You also benefit from:

- › Extensive product information
- › Preassembled thresholds
- › Support from start to finish
- › Our CE4ALL service platform

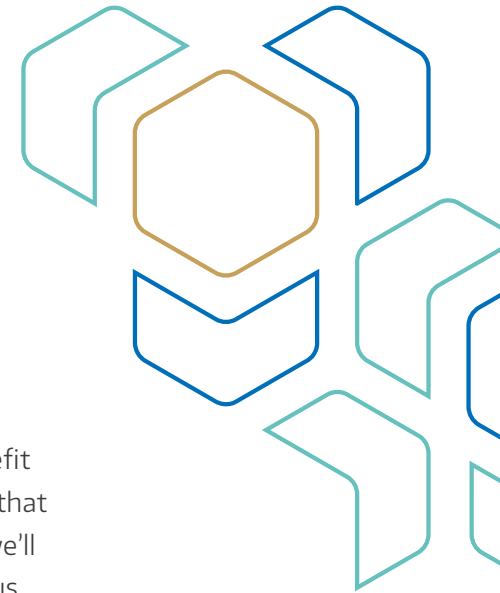

You want everything from a single source?

We provide you with complete solutions for sliding doors, windows and doors - for timber, PVC and aluminium. Experience our versatile system offer, comprehensive service included. Discover more of this on our website www.maco.eu or contact your MACO representative.



MACO near you:
www.maco.eu/contact



This document is constantly being revised.
The current version can be found under <https://www.maco.eu/assets/757970>
or scan the QR code.

Created: 12/2019
Order no. 757970
All rights and amendments reserved.